

MAGIC.SENS



This product information includes the entire MAGIC.SENS - product range.



BOSCH

Table of Contents

| | | |
|-----------|---|-----------|
| 1. | Foreword | 4 |
| 2. | Product Description | 5 |
| 2.1. | Configuration of the Detector | 5 |
| 2.2. | Functional Description of Sensor Technology | 5 |
| 2.3. | System Description MAGIC.SENS ... LSN | 6 |
| 2.3.1. | Features MAGIC.SENS ... LSN | 6 |
| 2.4. | System Description MAGIC.SENS ... GLT | 7 |
| 2.4.1. | Features MAGIC.SENS ... GLT | 7 |
| 3. | Planning Tips | 8 |
| 3.1. | Basic Planning Guidelines | 8 |
| 3.2. | Use on a Local Security Network (LSN) | 8 |
| 3.3. | Use with Conventional Line Technology (German: Gleichstrom Linientechnik, abbreviated GLT) | 8 |
| 3.4. | Use in Explosive Areas | 9 |
| 3.5. | Use in Areas with Elevated Radioactivity | 9 |
| 3.6. | Use in Fire Barriers according to DIBt | 9 |
| 4. | Programming | 10 |
| 4.1. | MAGIC.SENS OTC 410 LSN | 11 |
| 4.2. | MAGIC.SENS OC 410 LSN | 11 |
| 4.3. | MAGIC.SENS OT 400 E LSN | 12 |
| 4.4. | MAGIC.SENS O 400 E LSN | 12 |
| 4.5. | MAGIC.SENS T 400 E LSN | 13 |
| 4.5.1. | Sensitivity Classes according to EN 54 Part 5 | 13 |
| 5. | Technical Data: MAGIC.SENS | 14 |
| 5.1. | Technical Data: OTC 410 / OT 400 / OC 410 LSN | 14 |
| 5.2. | Technical Data: O 400 E LSN / T 400 E LSN | 15 |
| 5.3. | Technical Data: OC 310 GLT / OT 300 GLT / O 300 GLT | 16 |
| 5.4. | Technical Data: T 300 GLT / T 300 FSA GLT | 17 |
| 5.5. | Country Approvals | 18 |
| 6. | Detector Base | 21 |
| 6.1. | Detector Base MS 400 | 21 |
| 6.2. | Detector Base with Damp Room Seal MSF 400 | 23 |
| 6.3. | Additional Base MSC 420 | 23 |
| 6.4. | Detector Base Sirens MSS 300 / 400 / 401 | 24 |



| | | |
|------------|--|-----------|
| 7. | Accessories | 25 |
| 7.1. | Support Plates for Detector Zone Identification | 25 |
| 7.1.1. | Support Plate TP 4 400 | 25 |
| 7.1.2. | Support Plate TP 8 400 | 25 |
| 7.1.3. | Labels for Self-Labeling | 25 |
| 7.2. | Basket Guard SK 400 | 26 |
| 7.3. | Protective Dust Cover SSK 400 | 26 |
| 7.4. | Detector Console MK 400 | 26 |
| 7.5. | Detector Heating Element MH 400 | 26 |
| 7.6. | MPA External Detector Alarm Display | 27 |
| 8. | Order Overview | 29 |
| 8.1. | Detector Variants | 29 |
| 8.2. | Detectors for Special Applications | 29 |
| 8.3. | Detector Base | 30 |
| 8.4. | Detector Base Sirens | 30 |
| 8.5. | Installation Accessories | 31 |
| 8.6. | Detector Accessories | 31 |
| 8.7. | MPA External Detector Alarm Display | 31 |
| 9. | Installation of the Detector Module | 32 |
| 9.1. | Locking the Detector Module in the Base | 32 |
| 10. | Dismounting the Detector Module | 32 |
| 11. | Maintenance and Service | 33 |
| 11.1. | Notes for the Service: Display of Operating Data | 34 |
| 11.2. | Test Instructions for MAGIC.SENS Fire Detector | 36 |
| 11.7. | Coding of the Detector Types | 38 |
| 12. | Repair | 38 |
| 13. | Disposal | 38 |
| 14. | Additional Documentation | 38 |
| 14.1. | Service Accessories | 39 |
| 15. | Table of Abbreviations | 40 |
| 16. | Notes | 41 |

1. Foreword

The MAGIC .SENS fire detector series combines standard detection procedures such as scattered light measurement and temperature measurement in their highest stage of expansion with gas measurement technology.

Here, the signals of scattered light sensors, temperature sensors, and gas sensors are processed with the help of modern signal-processing procedures.

Thus security against deceptive alarms is increased significantly and detection time is reduced in comparison to the fire detectors available on the market today.

Thanks to the higher information content of the multisensor detectors, the use of detectors is also possible in environments where pure smoke detectors cannot be used.

The detectors are available in the following stages of expansion:

- Combined optical, thermal, gas-sensitive smoke detectors
- Combined optical, thermal smoke detectors
- Optical smoke detectors
- Thermal detectors
- Combined optical, gas-sensitive detectors

The line technology variants are:

- LSN (**L**ocal **S**ecurity**N**etwork)
- GLT (**G**leichstrom (conventional line)**t**echnology)

The cooperation of engineers and designers created the timeless, innovative design of this detector, which integrates pleasantly into the ceiling.

With this design it is possible to reconcile the contradictory goals of a generous installation space and a small detector.

The placement of the individual display on the detector tip is the first externally-visible characteristic of the installation-friendly development concept.

The form-stable and robust detector base must no longer be aligned using the position-independent position of the individual display.

It is suitable for surface and concealed mounting and provides separate mounting points for dropped ceiling / recessed sockets.

In addition, it fits all common bore patterns.

For surface mounting, the cable may be fed through on the side.

The integrated strain relief for false floor cables prevents cables from being pulled out of the terminal after installation.

The terminals are easily accessible, a retainer for the end resistance is integrated.

Cables up to 2.5 mm in diameter² can be used.

It can be expanded with a damp room seal so that with one base, all installation requirements can be met.

2. Product Description

2.1. Configuration of the Detector

- 1 = Smoke measuring chamber
(Optical sensor)
- 2 = Thermal sensor
- 3 = Chemical sensor
(covered on the
cross-section)
- 4 = Individual display
- 5 = PC board with evaluation
electronics
- 6 = Base MS 400

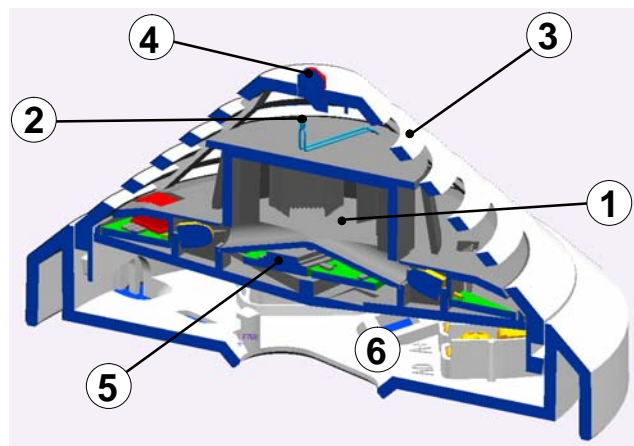

2.2. Functional Description of Sensor Technology

2.2.1. Optical sensor (smoke detector)

The optical sensor works according to the scattered light method.

A light diode sends light into the measuring chamber; this light is absorbed by the labyrinth structure. In case of fire, smoke enters the measuring chamber. The light is scattered by the smoke particles and hits the photo diodes that transform the quantity of light into a proportional electrical signal.

2.2.2. Thermal Sensor (temperature detector)

A thermistor (2) arranged on a resistance network serves as a thermal sensor on which an analog-digital converter measures the temperature-dependent voltage at cyclical intervals. Depending on the detector class set, the temperature measurement unit switches to an alarm state if the maximum temperature exceeds 54°C or 69°C (thermo-maximum) or a defined temperature increase within a particular time (thermo-differential).

2.2.3. Chemical sensor (CO gas sensor)

The main function of the gas sensor (3) is to detect carbon monoxide (CO) generated as a result of a fire, but it will also detect hydrogen (H) and nitrous monoxide (NO).

The underlying measurement principle is CO oxidation and the measurable current that it creates. The sensor signal value is proportional to the concentration of gas.

The gas sensor delivers additional information to effectively suppress deceptive values.



2.3. System Description MAGIC.SENS . . . LSN

Up to three detection principles are integrated into the multisensor detector MAGIC.SENS . . . 400/410 LSN:

- | | | |
|--|---|--------------------------|
| <ol style="list-style-type: none"> 1. Optical (for smoke) 2. Thermal (for heat) 3. Chemical (for gas) | } | OTC, OC, OT, O, T |
|--|---|--------------------------|

The individual sensors can be programmed via the LSN network manually or time-controlled. All sensor signals are evaluated continually by the internal signal analysis electronics and are linked with each other. By linking the sensors (combined detectors), the detector can also be used in places where the work carried out gives rise to light smoke, steam or dust. If with the OC, OT, O, and T detectors a signal combination fits the selected identifier for the area of operation, an alarm is triggered automatically.

2.3.1. Features MAGIC.SENS . . . LSN

- Active self-monitoring of the sensors, with display on the fire panel:
 - Display for defined sensor faults (life-zero monitoring),
 - Stepless display of the degree of contamination (only in service),
 - Fault indication with heavy contamination (instead of false alarm).
- Active adjustment of the threshold (drift compensation) if the optical sensor becomes contaminated.
- Active adjustment of the threshold (drift compensation) of the chemical sensor.
- The EMVsecurity is, with 30V/m in the range 1-1000MHz and with 40V/m in the cellular frequency ranges 415-466MHz and 890-960MHz, significantly higher than that required by VdS 2110 (VdS Schadenverhütung GmbH).
- Thanks to integrated isolators, the LSN ring will continue to function in case of wire breakage or short-circuit of a detector.
- Detector individual identification on the fire panel in case of alarm. Alarm display on the detector with a blinking red LED.
- Programmable, that is, can be adjusted to the area of operation.
- Increased detection and false alarm security thanks to evaluation of the temporal behavior of fire and disturbance variables.
- Manual or time-controlled switch-off of individual sensors for adjustment to extreme disturbance variables.
- Activation of a remote external detector alarm display is possible.
- Variable mechanical removal safeguard (can be activated/deactivated).
- Dust-resistant labyrinth and cap construction.
- Can be connected to the LSN – fire panel BZ 500 / universal European central unit UEZ 2000 / universal danger detection system UGM 2020 and to other central units or their receiver components with identical connection conditions.
- Depending on the central unit, using the WinPara program (Version 4.53 or higher) it is possible to read out the serial number, degree of contamination (for the O unit), operating hours, and current analog values for each configured detector.

2.4. System Description MAGIC.SENS . . . GLT

Up to two of the following detection principles are integrated into the multisensor detector MAGIC.SENS . . . 300/310 GLT:

- | | | |
|------------------------|---|---------------------|
| 1. Optical (for smoke) | } | OC, OT, O, T |
| 2. Thermal (for heat) | | |
| 3. Chemical (for gas) | | |

All sensor signals are evaluated continually by the internal signal analysis electronics and are linked with each other. If a signal combination fits into the detector's programmed identifier field, the alarm is triggered automatically.

By linking the sensors (combined detectors), the detector can also be used in places where the work carried out gives rise to light smoke, steam or dust.

2.4.1. Features MAGIC.SENS . . . GLT

- Active adjustment of the threshold (drift compensation) if the optical sensor becomes contaminated.
- Active adjustment of the threshold (drift compensation) of the chemical sensor.
- The EMVsecurity is, with 30V/m in the range 1-1000MHz and with 40V/m in the cellular frequency ranges 415-466MHz and 890-960MHz, significantly higher than that required by VdS 2110 (VdS Schadenverhütung GmbH).
- Activation of a remote external detector alarm display is possible.
- Variable mechanical removal safeguard (can be activated/deactivated).
- Dust-resistant labyrinth and cap construction.
- Can be connected to the GLT fire panels BZ 1012 / 1024 / 1060, universal European central unit UEZ 1000, universal danger detection system UGM 2020 and to other central units or their receiver components with identical connection conditions.

3. Planning Notes



MAGIC.SENS fire detectors are not intended for external use!

3.1. Basic Planning Specifications

- The planning of **multisensor fire detectors** (combination detectors) occurs according to the guidelines for optical detectors until an independent guideline has been worked out with the VdS.
- The types OTC, OC and OT are planned according to the guidelines for optical detectors if they are operated as optical detectors or combined detectors; see DIN VDE 0833 Part 2 and VDS 2095,
 - maximum monitoring area **120m²**,
 - installation height up to **16m**.
- If the occasional switching-off of the optical unit (scattered light sensor) is desired, the planning must occur according to the guidelines for heat detectors; see DIN VDE 0833 Part 2 and VDS 2095,
 - minimum monitoring area **40m²**,
 - installation height maximum **7.5m** for the T 400 E LSN or OT 400 E LSN,
 - installation height maximum **6m** for the T 300 GLT or OT 300 GLT.
- Maximum cable length: **1000m**, for J-Y(St) Y n x 2 x 0.6 / 0.8.
- Maximum permissible air speed: **20 m/s**.
- When planning for fire barriers according to DIBt, the following must be taken into account:
 - T 400 E LSN must be programmed according to class A1R,
 - the characteristic curve of the T 300 / FSA also corresponds to the A1R class.

3.2. Use on a Local Security Network (LSN)

On the LSN, up to 127 detectors can be operated in the following operating modes depending on the loop or stub:

| Detector type | Operating mode | | | |
|---------------|----------------|--------------|---------------------|--------------------------|
| | combined | only optical | only thermo-maximum | only thermo-differential |
| OTC 410 LSN | x | x | x | x |
| OC 410 LSN | x | x | - | - |
| OT 400 E LSN | x | x | x | x |
| O 400 E LSN | - | x | - | - |
| T 400 E LSN | - | - | x | x |

3.3. Use with Conventional Line Technology (German: Gleichstrom Linientechnik, abbreviated (GLT))

The GLT technology permits the connection of up to detectors to a primary line.



3.4. Use in Explosive Areas



All MAGIC.SENS detector types conform to the device category 3G, gas group IIB, and temperature class T6, in accordance with the European guideline 94/9/EG (ATEX). Thus the detectors may be used in Zone 2 areas where there is danger of explosion!

Limiting values:

- Detectors may only be operated with central units whose line output is energy-limited according to EN 50021.
 - ☞ This is a given for all Bosch fire panels.
- The line voltage (U_{max}) may not exceed 33V!
- The maximum current (I_{max}) must be limited to 130mA!
- The auxiliary voltage may not be fed through the ex area!

Fire detector cable:

- Only fire detector cables that conform to DIN VDE 0814 may be used.
- The entire cable capacity (C_{max}) may not exceed 1 μ F!
- The entire cable inductivity (L_{max}) may not exceed 0.01H!
 - ☞ The cable type J-Y(ST)Y08, according to DIN VDE 0815 (Table 10), has a capacity of 120 η F with a length of 1000m.

Detector heating element:

- The use of a detector heating element (MH 400) is not permissible!

3.5. Use in Areas with Elevated Radioactivity

- There are three LSN detector types available especially for use in areas with elevated radioactivity, such as in nuclear power plants:
 - Magic.Sens OT 400 LSN KKW
 - Magic.Sens O 400 LSN KKW
 - Magic.Sens T 400 LSN KKW

3.6. Use in Fire Barriers according to DIBt

- There are four detector types available for use in fire barriers according to the guideline of the DIBt (German Institute for Building Technology):
 - Magic.Sens O 400 LSN KKW
 - Magic.Sens T 400 LSN KKW
 - Magic.Sens O 300 GLT
 - Magic.Sens T 300 / FSA GLT

4. Programming

Programming is setting a LSN detector to the desired operating mode.

Programming is carried out with the >WinPara< software using a PC or laptop connected to the fire panel.

The detectors OTC 410 LSN OC 410 LSN and OT 400 E LSN are programmed by specifying the operation location (e.g. computer room, office, large kitchen).

The selection of the operation location determines the optimal characteristic diagram for fire and disturbance variable evaluation.

With low sensitivity of the optical sensor in the OTC 410 LSN, the detector only triggers if smoke and also an increase of the CO concentration or the temperature is detected.

With the types OTC 410 LSN and OT 400 E LSN, the operating mode can be changed. That is, individual sensors can be switched off:

- Switch to optical (sensitivity O unit = low, T unit = switched off)
- Switchover to thermo-differential (sensitivity T unit = A2R, O unit = switched off)
- Switchover to thermo-maximum (sensitivity T unit = A2S, O unit = switched off)

With purely optical detectors O 400 E LSN, the sensitivity of the optical sensors can be set on 3 levels. Depending on the operation location, the optical sensor in the detector is thus adjusted to the environmental conditions.

For fire recognition, the optical detector uses the temporal behavior of the fire variables that deviates significantly from the temporal behavior of disturbance variables and also from the time behavior of a detector test with aerosol. Depending on the sensitivity set, therefore there are also different trigger times when testing with a test aerosol, outside of maintenance operation (10s to max 60s).

The thermal detector T 400 E LSN is programmed by taking into account the ambient temperature and installation height with the selection of the sensitivity class.

Programming of the optical, thermal, and chemical detector and the linking of all detectors via algorithms significantly increases the detection ability and security against false alarms.

4.1. MAGIC.SENS OTC 410 LSN

| Operation locations that can be selected in the >WinPara< programming software | Detector type | Sensitivity | | |
|--|--|-------------------------|---------|----------|
| | | T _{max} - unit | O- unit | C - unit |
| Theaters / Concert Halls | combined O + T _{max} + T _{diff} + C | high (A2) | medium | high |
| Warehouse with vehicle traffic | combined O + T _{max} + T _{diff} + C | low (B) | low* | low |
| Office (smokers) / Restaurant / Waiting room / Conference room | combined O + T _{max} + T _{diff} + C | high (A2) | low* | low |
| Conference room / Waiting room / Exhibition hall | combined O + T _{max} + T _{diff} + C | high (A2) | low* | medium |
| Office (no traffic) | combined O + T _{max} + T _{diff} + C | high (A2) | high | high |
| School / Kindergarten | combined O + T _{max} + T _{diff} + C | high (A2) | medium | high |
| Garage | combined O + T _{max} + T _{diff} + C | high (A2) | low* | low |
| Kitchen / Casino / Restaurant during active operation | combined O + T _{max} + C | low (B) | low* | low |
| Production Facilities | combined O + T _{max} + T _{diff} + C | low (B) | low* | medium |
| Computer room | combined O + T _{max} + T _{diff} + C | high (A2) | high | high |
| High-board warehouse without vehicle traffic with combustion motors. | combined O + T _{max} + T _{diff} + C | low (B) | high | high |
| Office (daily operation) | combined O + T _{max} + T _{diff} + C | low (B) | medium | high |

*With low sensitivity of the optical sensor, the detector only triggers if smoke and also an increase of the CO concentration or the temperature is detected.

4.2. MAGIC.SENS OC 410 LSN

| Operation locations that can be selected in the >WinPara< programming software | Detector type | Sensitivity | |
|--|------------------|-------------|---|
| | | O - unit | C - unit |
| Theaters / Concert Halls | combined (O + C) | medium | The sensitivity of the C unit is always equally high, regardless of the operation location. |
| Warehouse with vehicle traffic | combined (O + C) | low | |
| Office (smokers) / Waiting room / Restaurant / Conference room | combined (O + C) | low | |
| Conference room / Waiting room / Exhibition hall | combined (O + C) | low | |
| Office (no traffic) | combined (O + C) | high | |
| School / Kindergarten | combined (O + C) | medium | |
| Garage | combined (O + C) | low | |
| Kitchen / Casino / Restaurant during operation | combined (O + C) | low | |
| Production Facilities | combined (O + C) | low | |
| Computer room | combined (O + C) | high | |
| High-board warehouse without vehicle traffic with combustion motors | combined (O + C) | high | |
| Office (daily operation) | combined (O + C) | medium | |

4.3. MAGIC.SENS OT 400 E LSN

| Operation locations that can be selected in the >WinPara< programming software | Detector type | Sensitivity | |
|--|--|-------------------------|---------|
| | | T _{max} - unit | O- unit |
| Theaters / Concert Halls | combined O + T _{max} + T _{diff} | high (A2) | medium |
| Warehouse with vehicle traffic | combined O + T _{max} + T _{diff} | low (B) | low |
| Office (smokers) / Waiting room / Restaurant / Conference room | combined O + T _{max} + T _{diff} | high (A2) | low |
| Conference room / Waiting room / Exhibition hall | combined O + T _{max} + T _{diff} | high (A2) | low |
| Office (no traffic) | combined O + T _{max} + T _{diff} | high (A2) | high |
| School / Kindergarten | combined O + T _{max} + T _{diff} | high (A2) | medium |
| Garage | T _{max} + T _{diff} | high (A2) | - |
| Kitchen / Casino / Restaurant (during operation) | T _{max} | low (B) | - |
| Production Facilities | combined O + T _{max} + T _{diff} | low (B) | low |
| Computer room | combined O + T _{max} + T _{diff} | high (A2) | high |
| High-board warehouse without vehicle traffic with combustion motors | combined O + T _{max} + T _{diff} | low (B) | high |
| Office (daily operation) | combined O + T _{max} + T _{diff} | low (B) | medium |

4.4. MAGIC.SENS O 400 E LSN

| Operation location and recommended setting in the >WinPara< programming software | Sensitivity O- unit |
|--|---------------------|
| Theaters / Concert Halls | medium |
| Warehouse with vehicle traffic | low |
| Office (smokers) / Waiting room / Restaurant / Conference room | low |
| Conference room / Waiting room / Exhibition hall | low |
| Office (no traffic) | high |
| School / Kindergarten | medium |
| Production Facilities | low |
| Computer room | high |
| High-board warehouse without vehicle traffic with combustion motors | high |
| Office (daily operation) | medium |



For fire detection, the purely optical detector also evaluates the time behavior of the fire characteristics that differs significantly from the time behavior of characteristics during a detector test. Depending on the sensitivity set, therefore there are also different trigger times when testing with a test aerosol, outside of maintenance operation (10s to max 60s).

4.5. MAGIC.SENS T 400 E LSN

| Selectable sensitivity classes in the >WinPara< programming software | |
|--|---|
| § A2R | Typical application temperature: 25°C, $T_{\max} + T_{\text{diff}}$, height up to 6m |
| A2S | Typical application temperature: 25°C, only T_{\max} , height up to 6m |
| A1R | Typical application temperature: 25°C, $T_{\max} + T_{\text{diff}}$, height 6 - 7.5m |
| A1 | Typical application temperature: 25°C, only T_{\max} , height 6 - 7.5m |
| BR | Typical application temperature: 40°C, $T_{\max} + T_{\text{diff}}$, height up to 6m |
| BS | Typical application temperature: 40°C, only T_{\max} , height up to 6m |

§ = basic setting in the >WinPara< programming software

ⓘ During installation for automatic door control according to DIBt, the detector must be programmed according to the class A1R!

4.5.1. Sensitivity classes according to EN 54 Part 5

The MAGIC.SENS T 400 E LSN gives you the opportunity, according to the programming, to specify one of the six sensitivity classes listed above.

In the sensitivity classes A1, A2S and BS, the MAGIC.SENS T 400 E LSN is operated as a pure thermo-maximum detector.

Here in the class A2S the detector does not activate under 54°C and in class BS not under 69°C.

The sensitivity classes A2S and BS are therefore especially suitable for applications where over a longer period, higher temperature rates-of-rise occur, e.g. in kitchens or boiler rooms.

The sensitivity classes A1R, A2R and BR mean that in addition to the thermomax unit, the thermodifferential unit is also active.

These sensitivity classes are especially well-suited for use in unheated buildings where the ambient temperature can vary greatly but temperature rates-of-rise do not last long.

⚠ With the thermodifferential unit, the detectors in classes A1R/A2R activate at $T < 54^\circ\text{C}$ and in class BR at $T < 69^\circ\text{C}$; see table page 15.

The selection of the sensitivity class also depends on the installation height of the detector (see table above).

For the highest security against false alarms, with room heights below 6 m, the classes A1 and A1R should not be selected, although this is allowed in principle. Furthermore, the expected application temperature must be taken into consideration.

5. Technical Data MAGIC.SENS

5.1. Technical Data: OTC 410 / OT 400 / OC 410 LSN

| Detector type | OTC 410 LSN | OT 400 E LSN | OC 410 LSN |
|--|--|--|---|
| Detection principle | Combination of: - Scattered light measurement - Measurement of absolute temperature and temperature increase - Combustion gas measurement | Combination of: - Scattered light measurement - Measurement of absolute temperature and temperature increase | Combination of: - Scattered light measurement - Combustion gas measurement |
| Special features | Contamination detection Drift compensation in optical unit and in gas measuring unit Operation switching / sensor switching-off in the optical unit and in the thermal unit. | Contamination detection Drift compensation in optical unit Operation switching / sensor switching-off in the optical unit and in the thermal unit. | Contamination detection Drift compensation in optical unit and in gas measuring unit |
| Operating voltage | 20V DC . . . 33 V DC | | |
| Current consumption | < 0.7mA | | |
| Individual display | LED red | | |
| Alarm output | per data word via two-wire signal line | | |
| Indicator output | Open collector, puts through 0 Volt via 1.5k Ω , max. 15mA | | |
| Response sensitivity (basic data) | O unit: < 0.15 dB/m (EN 54 T7) T unit: EN 54-5 Thermomax unit:> 54/69°C Thermodifferential unit: see table on page 15 Gas unit: in ppm range | O unit: < 0.15 dB/m (EN 54 T7) T unit: EN 54-5 Thermomax unit:> 54/69°C Thermodifferential unit: see table on page 15 OT according to CEA | O unit: < 0.15 dB/m (EN 54 T7) Gas unit: in ppm range |
| max. monitoring range | 120 m ² (note VdS-guidelines) | | |
| maximum mounting height | 16 m (note VdS-guidelines) | | |
| permissible airspeed | 20m/s | | |
| Permissible operating temperature | - 10°C . . . +50°C | - 20°C . . . +50°C or +65°C | - 10°C . . . +50°C |
| permissible relative humidity | < 95 % (non-condensing) | | |
| Protection category according to EN 60 529 | IP 30 | | |
| Color code | yellow ring | black ring | blue ring |
| Dimensions | \varnothing 99.5 x 52 mm (without base) / \varnothing 120 x 63.5 mm (with base) | | |
| Housing material, housing color | ABS (Novodur) / white, similar to RAL 9010, matte surface | | |
| Product ID | 4.998.101.151 | 4.998.130.602 | 4.998.101.152 |

5.2. Technical Data: O 400 E LSN / T 400 E LSN

| Detector type | O 400 E LSN | T 400 E LSN |
|--|---|--|
| Detection principle | Scattered light measurement | Measurement of absolute temperature and temperature increase |
| Special features | Contamination detection Drift compensation in optical unit | |
| Operating voltage | 20V DC . . . 33V DC | |
| Current consumption | < 0.7mA | |
| Individual display | LED red | |
| Alarm output | per data word via two-wire signal line | |
| Indicator output | max. 15mA (in case of alarm 0 volts is put through) | |
| Response sensitivity (basic data) | < 0,15 dB/m (EN 54 T7) | Thermomaximum unit:> 54°C / > 69°C Thermodifferential unit: according to EN 54 T5 (see table below) |
| max. monitoring area | 120 m ² (note VdS-guidelines) | 40 m ² (note VdS-guidelines) |
| maximum mounting height | 16 m (note VdS-guidelines) | 7,5 m (note VdS-guidelines) |
| permissible airspeed | 20m/s | |
| permissible operation temperature | - 20°C . . . +65°C | - 20°C . . . +50°C or +65°C |
| Permissible relative humidity | < 95 % (non-condensing) | |
| Protection category according to EN 60 529 | IP 30 | |
| Color code | - | red ring |
| Dimensions | Ø 99.5 x 52mm (without base) / Ø 120 x 63.5mm (with base) | |
| Housing material - / Color | ABS (Novodur) / white, similar to RAL 9010, matte surface | |
| Product ID | 4.998.121.032 | 4.998.130.603 |

Table: Response sensitivity of the thermodifferential unit according to EN 54-5

| Temperature rate-of-rise [K min ⁻¹] | Response time for detectors in the sensitivity class A1R | | Response time for detectors in sensitivity classes A2R / BR | |
|---|--|----------------------------------|---|----------------------------------|
| | Lower limiting value [min / sec] | Upper limiting value [min / sec] | Lower limiting value [min / sec] | Upper limiting value [min / sec] |
| 10 | 1 min | 4 min 20 sec | 2 min | 5 min 30 sec |
| 20 | 30 sec | 2 min 20 sec | 1 min | 3 min 13 sec |
| 30 | 20 sec | 1 min 40 sec | 40 sec | 2 min 25 sec |

5.3. Technical Data: OC 310 GLT / OT 300 GLT / O 300 GLT

| Detector type | OC 310 | OT 300 | O 300 |
|--|---|--|--------------------------------|
| Detection principle | Combination of: - Scattered light measurement - Gas measurement | Combination of: - Scattered light measurement - Measurement of absolute temperature and temperature increase | Scattered light measurement |
| Special features | Drift compensation in optical unit and in gas measuring unit | Drift compensation in optical unit | |
| Operating voltage | 12V DC . . . 28V DC | | |
| Current consumption | < 0.1mA | | |
| Individual display | LED red | | |
| Alarm output | Current increase (alarm resistance approximately 800Ω) | | |
| Indicator output | Open collector, puts through 0 Volt via 3.92kΩ, max. 15mA | | |
| Response sensitivity (basic data) | O unit: < 0.15 dB/m (EN 54 T7) Gas unit: in the ppm range | O unit: < 0.15 dB/m (EN 54 T7) T unit: EN 54-5 Thermomaximum unit: > 54°C Thermodifferential unit: see table on page 15 | O unit: < 0.15 dB/m (EN 54 T7) |
| max. monitoring area | 120 m ² (note VdS-guidelines) | | |
| maximum mounting height | 16 m (note VdS-guidelines) | | |
| permissible airspeed | 20m/s | | |
| Permissible operating temperature | - 10°C . . . +50°C | - 20°C . . . +50°C | - 20°C . . . +65°C |
| permissible relative humidity | < 95 % (non-condensing) | | |
| Protection category according to EN 60 529 | IP 30 | | |
| Color code | blue ring | black ring | - |
| Dimensions | Ø 99.5 x 52 mm (without base) / Ø 120 x 63.5 mm (with base) | | |
| Housing material - / Color | ABS (Novodur) / white, similar to RAL 9010, matte surface | | |
| Product ID | 4.998.101.153 | 4.998.025.351 | 4.998.117.239 |

5.4. Technical data: T 300 GLT / T 300 FSA GLT

| Detector type | T 300 | T 300 / FSA |
|--|---|---|
| Detection principle | Measurement of absolute temperature and temperature increase | Measurement of absolute temperature and temperature increase |
| Special features | Class A2R according to EN 54-5 | Goods monitoring for fire barriers according to DIBt. Characteristic curve according to class A1R according to EN 54-5 |
| Operating voltage | 12V DC . . . 28V DC | |
| Current consumption | < 0.1mA | |
| Individual display | LED red | |
| Alarm output | Current increase (alarm resistance approximately 800Ω) | |
| Indicator output | Open collector, puts through 0 Volt via 3.92kΩ, max. 15mA | |
| Response sensitivity (basic data) | T unit: EN 54-5 Thermomaximum unit: > 54°C Thermodifferential unit: see table on page15 | T unit: EN 54-5 Thermomaximum unit: > 54°C Thermodifferential unit: see table on page15 |
| max. monitoring area | 40m ² (note VdS-guidelines) | 40m ² (note VdS-guidelines) |
| maximum mounting height | 6m (note VdS-guidelines) | 6m (note VdS-guidelines) |
| permissible airspeed | 20m/s | |
| Permissible operating temperature | - 20°C . . . +50°C | - 20°C . . . +50°C |
| permissible relative humidity | <95% (non-condensing) | |
| Protection category according to EN 60 529 | IP 30 | |
| Color code | red ring | red ring |
| Dimensions | Ø 99.5 x 52mm (without base) / Ø 120 x 63.5mm (with base) | |
| Housing material - / Color | ABS (Novodur) / white, similar to RAL 9010, matte surface | |
| Product ID | 4.998.025.354 | 4.998.107.056 |

5.5. Country approvals

| Country | Approval institution | Detector type | Approval no. |
|--------------------|--|--|--|
| Germany (D) | VdS Schadenverhütung GmbH | OTC 410 LSN | G 201 081 |
| | | OC 410 LSN | G 201 080 |
| | | OT 400 E LSN | G 202 045 |
| | | O 400 E LSN | G 202 044 |
| | | T 400 E LSN | G 202 043 |
| | | OT 400 LSN KKW | G 299 092 |
| | | O 400 LSN KKW | |
| | | T 400 LSN KKW | |
| | | OC 310 GLT | G 201 078 |
| | | OT 300 GLT | G 299 089 |
| | O 300 GLT | G 299 088 | |
| | T 300 GLT | G 299 087 | |
| | DIBt German Institute for Building Technology | OT 400 LSN KKW O 400 LSN KKW T 400 LSN KKW | Z-6.5-1629 Z-6.5-1630 Z-6.5-1631 |
| | | T 300 GLT | Z-6.5-1646 |
| | PTB Physical. - Technical Federal Institute | all types | PTB Ex 01 - 20320 |
| Belgium (B) | BOSEC Belgian Organization for Security Certification | O 400 E LSN | TCC 2 - 286 |
| | | T 400 E LSN | TCC 2 -285 |
| Bulgaria (BG) | National Bureau "Fire- and Accident Protection", Scientific Practical Institute for Fire and Accident Protection" | OT 400 E LSN O 400 E LSN T 400 E LSN OT 300 GLT O 300 GLT T 300 GLT | IN 79 / 11.02.2000 |
| Denmark (DK) | DANAK Dansk Brand- og sikringsteknisk Institut DIFT Danish Institute of Fire Technology | OT 400 E LSN | 232.1102 |
| | | O 400 E LSN | 232.1100 |
| | | T 400 E LSN | 232.1101 |
| | | O 300 GLT | 232.1103 |
| | | T 300 GLT | 232.1104 |
| Estonia (EST) | TÜV NORD BALTIC OÜ EESTI VABARIIK | O 300 GLT | 1325/03 |
| | | OC 310 GLT | |
| | | O 400 LSN | |
| | | OC 410 LSN | |
| | | OT 300 GLT | 1326/03 |
| | | OT 400 LSN | |
| | | OTC 410 LSN | |

Country approvals (continued)

| Country | Approval institution | Detector type | Approval no. |
|-------------------|---|--------------------------------------|--------------|
| Hong Kong (HK) | Fire Services Department Licensing and Certification Command | OT 400 E LSN | FP 206/1188 |
| | | O 400 E LSN | |
| | | T 400 E LSN | |
| Israel (IL) | ISI Israel Standards Institute | OT 400 E LSN | 801 433 2544 |
| | | O 400 E LSN | 801 433 254% |
| Croatia (HR) | EUROCONTROL ZAGREB, Surveillance and Trading Service, Zagreb | OT 300 GLT O 300 GLT T 300 GLT | 103-SF/02 |
| Lithuania (LT) | <i>Priešgaisrinis Apsaugos Ir Gelbėjimo Departamentas;</i> <i>Prie Lietuvos Respublikos Vidaus Reikalų Ministerijos Gaisrinio Tyrimo Centras</i> | O 300 GLT | GTC 100162 |
| | | O 400 GLT | |
| | | T 300 GLT | GTC 100160 |
| | | T 400 LSN | |
| | | OT 400 LSN | GTC 100165 |
| | | OTC 410 LSN | |
| Poland (PL) | CNBOP Centrum Naukowo - Badawcze Ochrony Przeciwpozarowej | OTC 410 LSN | 1329.2003 |
| | | OC 410 LSN | 1328.2003 |
| | | OT 400 LSN | 1327.2003 |
| | | O 400 LSN | 1326.2003 |
| | | T 400 GLT | 1325.2003 |
| Russia (RUS) | Национальное агентство по техническому регулированию и метрологии | OT 400 E LSN OT 300 GLT | B 01702 |
| | | OT 400 E LSN OT 300 GLT | |
| | | OT 400 E LSN OT 300 GLT | B 01703 |
| Slovenia (SLO) | Laboratorij za procesno merilno tehniko Laboratorij za magnetna merenja | O 400 E LSN | 02015-C-172 |
| | | T 400 E LSN | |
| Spain (E) | Ministerio de Ciencia y Tecnologia; Subdirección General de Calidad y Seguridad Industrial | OTC 310 GLT | G 201 079 |
| | | OC 310 GLT | G 201 078 |
| | | OTC 410 LSN | G 201 081 |
| | | OC 410 LSN | G 201 080 |

Country approvals (continued)

| Country | Approval institution | Detector type | Approval no. |
|-------------------------------|---|-----------------|-----------------|
| Czech Republic (CZ) | ACR Czech Army | OTC 410 LSN | applied for |
| | PAVÚS Brandatestationinstitut | | 08-0017 |
| | NBU National Security Bureau | | T 4016/2002 |
| | ACR Czech Army | OC 410 LSN | applied for |
| | PAVÚS Brandatestationinstitut | | 00-0020 |
| | NBU National Security Bureau | | T 4015/2002 |
| | ACR Czech Army | OT 400 E LSN | 321/30 -3/049/2 |
| | PAVÚS Brandatestationinstitut | | C-00-033 |
| | NBU National Security Bureau | | T 40139 |
| | ACR Czech Army | O 400 E LSN | 321/30 -3/049/3 |
| | PAVÚS Brandatestationinstitut | | C-00-031 |
| | NBU National Security Bureau | | T 40137 |
| | ACR Czech Army | T 400 E LSN | 321/30 -3/049/4 |
| | PAVÚS Brandatestationinstitut | | C-00-032 |
| | NBU National Security Bureau | | T 40138 |
| | ACR Czech Army | OC 310 GLT | applied for |
| | PAVÚS Brandatestationinstitut | | 08-0020 |
| | NBU National Security Bureau | | T 4015/2002 |
| | ACR Czech Army | OT 300 GLT | 321/30 -3/049/2 |
| | PAVÚS Brandatestationinstitut | | 00-0033 |
| | NBU National Security Bureau | | T 40139 |
| | ACR Czech Army | O 300 GLT | 321/30 -3/049/3 |
| | PAVÚS Brandatestationinstitut | | C-00-031 |
| | NBU National Security Bureau | | T 40137 |
| ACR Czech Army | T 300 GLT | 321/30 -3/049/4 | |
| PAVÚS Brandatestationinstitut | | C-00-032 | |
| NBU National Security Bureau | | T 40138 | |
| Hungary (HU) | BM OKF Belügyminiszterium Országos Katasztrófavédelmi Főigazgatóság | OTC 410 LSN | 618/73-1/2001 |
| | | OC 410 LSN | 618/73-2/2001 |
| | | OT 400 E LSN | 618/22-3/2000 |
| | | O 400 E LSN | 618/22-1/2000 |
| | | T 400 E LSN | 618/22-3/2000 |
| | | OC 310 GLT | 618/73-3/2001 |

6. Detector base

6.1. Detector base MS 400

The MAGIC SENS detector module is placed in the MS 400 detector base, which is used for both concealed and surface cable insertion.

The detector base is made of white ABS plastic (Novodur, color similar to RAL 9010) and it has a matte surface. The base has 7 screw terminals for the connection of the detector and its accessories to the fire panel.

Contacts connected with the terminals guarantee a secure electric connection when installing the MAGIC SENS detector module.

6.1.1. Installation instructions for the MS 400 detector base

The detector base is screwed to the even, dry subsurface with 2 screws at a distance of approximately 55 mm.

For cable insertion for surface mounting (aP), break out the prepared entry points (X) on the external detector alarm display housing.

For concealed cable insertion (uP), feed the cable through the opening in the middle of the base.

The long holes marked in the sketch with "Y" are intended for base installation on a concealed box and should only be used for this.

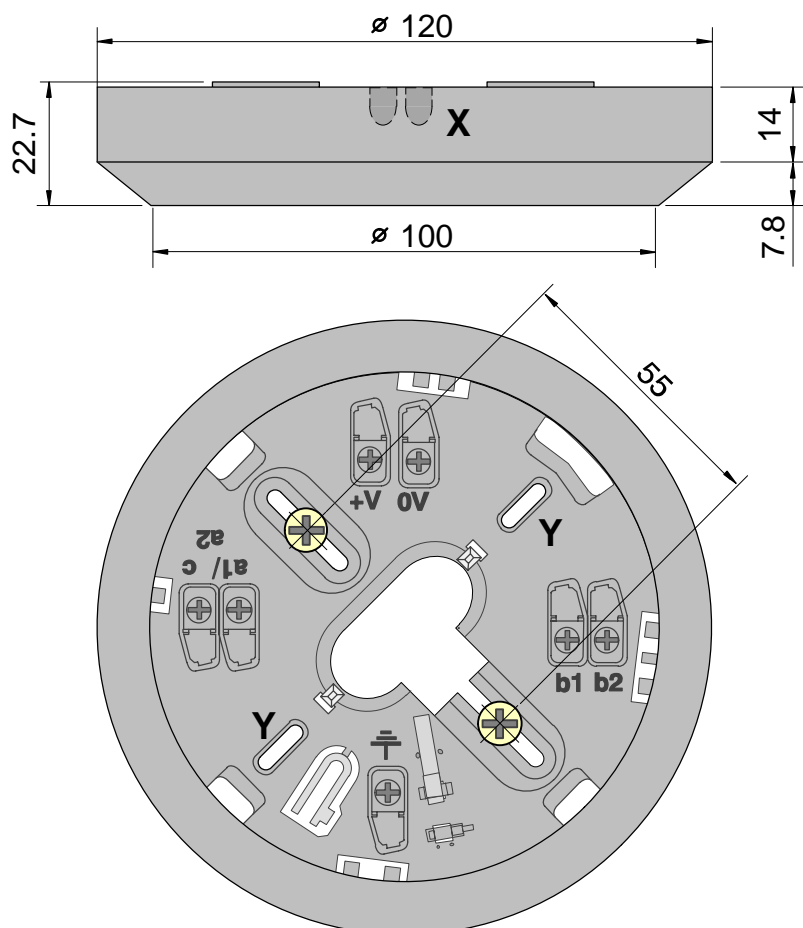

6.1.2. Connection of the detector base MS 400 (surface cable insertion)

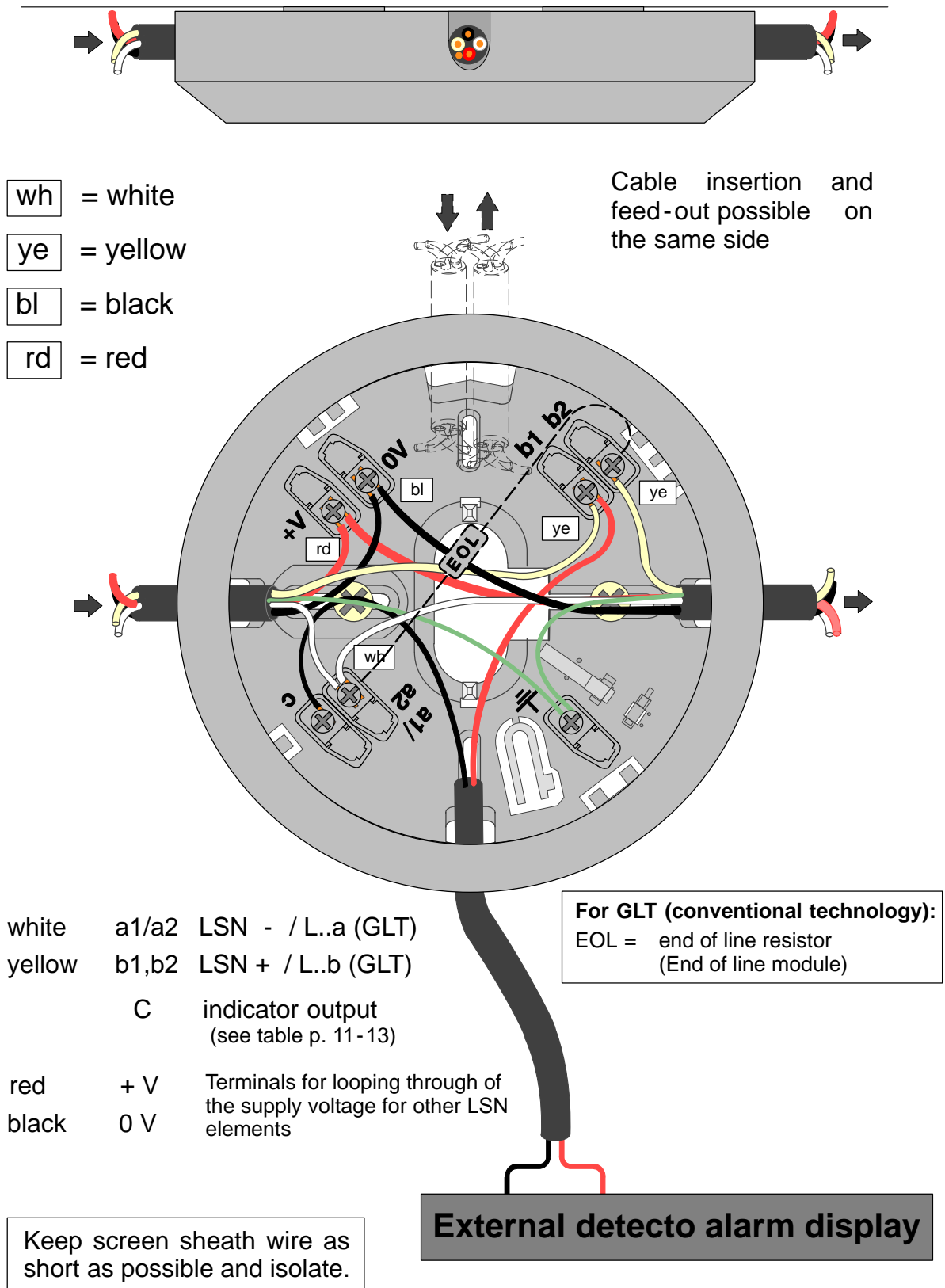

6.2. Detector Base with Damp Room Seal MSF 400

For use of the detector in a humid environment, there is the MSF 400 detector base.

The MSF 400 detector base with integrated seal of TPE protects the detector reliably against the penetration of condensed water.

Concealed and surface cable insertion possible.



6.3. Additional Base MSC 420

The additional base MSC 420 was conceived specially for surface-mounted cable ducts through cable protection conduits and it has 2 opposing pre-cut inputs with \varnothing 20mm and 2 additional opposing and prepared inputs for up to 28 mm diameter. The additional base has a diameter of 120mm and a height of 35mm.

To protect against condensed water penetration, a seal is placed on the bottom of the MSC 420.



6.4. Detector Base Sirens MSS 300 / 400 / 401

If directly at the location of the fire the acoustic signaling of an alarm is required, the detector base sirens, available in 8 variants, are used.

- Detector base siren MSS 300 in white and red, for the conventional line technology and connection via the C-point of the detector.
- Detector base siren MSS 300 WS-EC in white, for the conventional line technology with external activation.
- Detector base siren MSS 400 in white and red, for the modern line technology LSN, with power supply by the LSN.
- Detector base siren MSS 401 in white and red, for the modern line technology LSN, with separate power supply.

Detector base type SA in white and red are delivered with a cover plate and are intended only for installation as independent signaling devices.

The integrated tone generator has 11 tones for selection (incl. tones according to DIN 33404 and EN 457) with acoustic pressure of max. 100 dBA, depending on the type of tone selected.

With the LSN variants, the volume (4 levels) and also the tone type are programmed via the fire panel.

The GLT variants are set using DIP switches and a potentiometer.

Cable insertion "surface" and "concealed" possible.

Depending on the signal selected, individual tone types can be set with connection to the Bosch central unit UEZ 2000 LSN for pre-alarm and alarm.

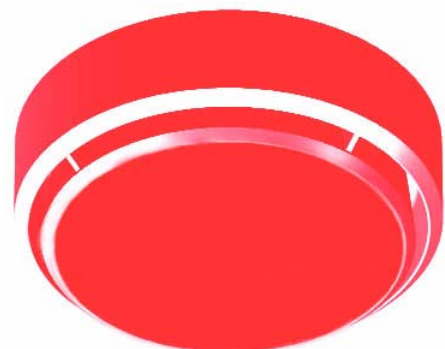
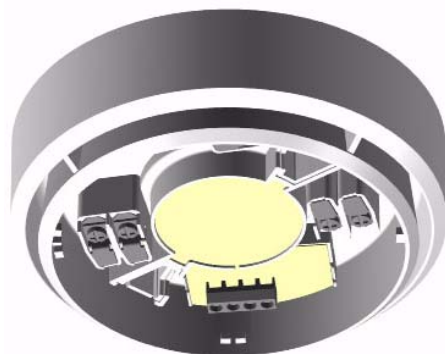

7. Accessories

7.1. Support Plates for Detector Zones Identification

The support plates are made of 1.8 mm thick ABS - plastic (Novodur, color similar to RAL 9010) and are clamped between the detector base and the ceiling.

7.1.1. Support plate TP 4 400

The support plate TP 4 400 is intended for an installation height up to 4m and is designed for labels up to a size of approximately 65 x 34 mm.

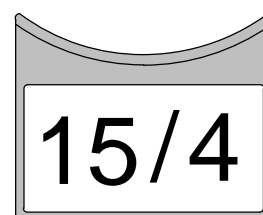

7.1.2. Support plate TP 8,400

The support plate TP 8,400 is intended for an installation height up to 8m and is designed for labels up to a size of approximately 97 x 44 mm.

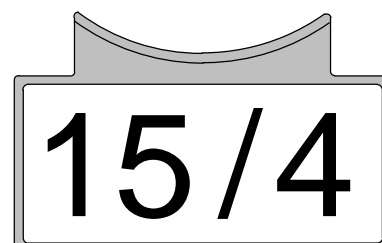

7.1.3. Labels for Self-Labeling

Labels by the Fa. Zweckform have proven practical.

The self-adhesive labels are made of sturdy white polyester film and can be labeled with a laser printer or copier.

| Label size | Zweckf. item no. | Scope of delivery |
|----------------|------------------|------------------------------|
| 64.6 x 33.8 mm | 4773 | 1 DIN A4 sheets of 24 labels |
| 97.0 x 42.3 mm | 4776 | 1 DIN A4 sheets of 12 labels |

7.2. Basket Guard SK 400

The basket guard SK 400 is installed over the detector and protects the detector against damage to the greatest possible extent.

If the detector is mounted in a sports facility, for example, the basket guard prevents balls or other sports equipment from hitting the detector and damaging it.

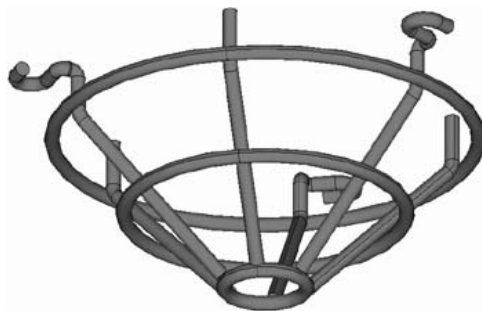

7.3. Protective dust cover SSK 400

The protective dust cover SSK 400 is necessary during construction work to protect an installed detector base, with or without detector head, from contamination. The protective dust cover made of polypropylene (PP) is pushed onto the installed detector base.



7.4. Detector console MK 400

The detector console MK 400 is used for the DIBt-conforming installation of detectors above frame sets, etc. The console is delivered with a pre-installed base.



7.5. Detector Heating Element MH 400

The detector heating element MH 400 is required if the detector is used in an environment where water condensation can occur, such as in a warehouse that must be opened briefly for delivery vehicles.

The detector heating element is connected to the terminals + V / 0V in the detector base. Operating voltage: 24V DC, resistance: 1k Ω , power consumption: 3W.

The heating is supplied with power either by the fed-through supply voltage via the central unit or by a separate power supply.

With supply via the central unit, the number of detector heating elements depends on the cable diameter and line length used.

7.6. MPA External Detector Alarm Display

The MPA external detector alarm display is required if the detector is not directly visible or has been mounted in false ceilings / or floors.

The MPA should be mounted in corridors or access pathways to the corresponding building sections or rooms.

The red alarm display (A) corresponds to DIN 14 623.

7.6.1. Use of the MPA in explosive areas



The external detector alarm display conforms to the device category 3G, gas group IIB, and temperature class T6, in accordance with the European guideline 94/9/EG (ATEX). Thus the external detector alarm display may be used in Zone 2 areas where there is danger of explosion!

- The connection conditions (see next page) must absolutely be adhered to!

7.6.2. Mounting hints

- Mounting directly on the ceiling or wall.
- For surface-mounted cable insertion (aP), break out the inputs (X) prepared on the housing. For cable insertion below the surface (uP), the cable is inserted through the opening below the connection board.



According to VdS guidelines, the MPA must be mounted so that the flat side of the prism (Y) shows in the observer's line of sight.

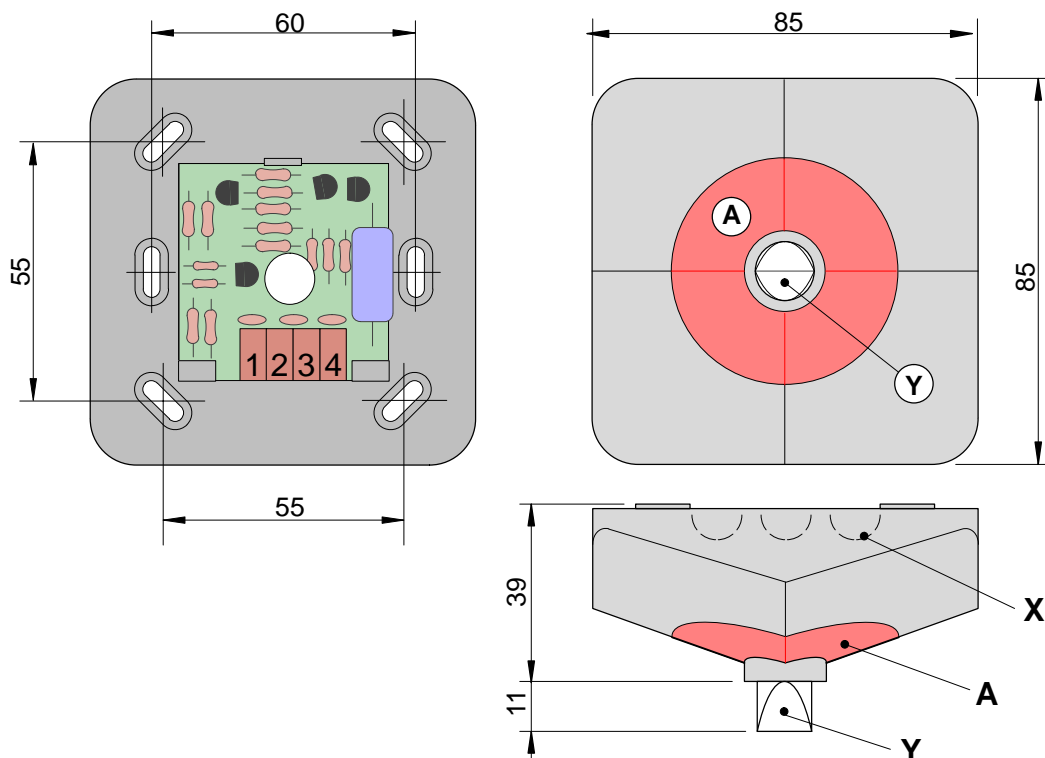

7.6.3. Connecting the MPA

The MPA external detector alarm display is connected using 4 Wago clamps.

Clamping on: insert isolated solid wire into the clamp.

Disconnecting: Turn wire alternately to the left and right , thus pulling it out of the terminal.

Up to 4 detectors can be connected to each MPA.

Three inputs (T. 2 – 4) allow adjustment to the various line networks. If used in ex-area, only 2 inputs (T.3 and T. 4) can be used!

Connecting depending on the line technique used

| Line technique | Fire panels | Terminals |
|----------------|--------------------------------------|-----------|
| GLT | BZ 1060 | T.1 + T.2 |
| GLT | UEZ 1000, UGM 2020, FP 102, 104, 106 | T.1 + T.3 |
| LSN | BZ 500, UEZ 1000, UEZ 2000, UGM 2020 | T.1 + T.4 |

Connection when using in explosive areas of the Zone 2

| Line technique | Fire panels | Terminals |
|----------------|--------------------------------------|-----------|
| GLT | UGM 2020, FP 102, FP 104, FP 106 | T.1 + T.3 |
| LSN | BZ 500, UEZ 1000, UEZ 2000, UGM 2020 | T.1 + T.4 |

☞ **Short-circuit T. 1 and T. 2; limit T. 4 to maximum of 20mA!**

Terminal occupation

T.1: Ground

T.2: Input blinking (LED blinks),

T.3: Input static (LED lights up),

T.4: Input static (LED lights up)

On T.4 only connect via a current limiting resistor (integrated in LSN detector); otherwise, the LED could be destroyed.

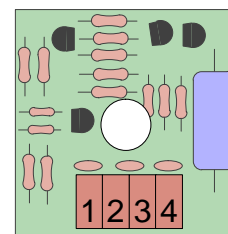

7.6.4. MPA Technical Data

| | | |
|---------------------------------|-----------------------------|---------------------------------|
| Operating voltage | 9 V DC . . . 30 V DC | |
| Current consumption for display | T.2 | approx. 2 mA |
| | T.3 | limited to approx. 13 mA |
| | T.4 | limited to approx. 20 mA |
| Weight | 65 g | |
| Display medium | 1 LED via a light conductor | |
| Permissible wire diameter | 0.6 mm -0.8 mm | |
| VdS ID number | G 294 052 | |

8. Order overview

8.1. Detector variants

| Product ID | LE* | Designation |
|---------------|-----|---|
| 4.998.101.151 | ST | OTC 410 LSN Multi-sensor detector optical / thermal / chemo |
| 4.998.101.152 | ST | OC 410 LSN Multisensor detector optical / chemo |
| 4.998.130.602 | ST | OT 400 E LSN Multisensor detector optical / thermal |
| 4.998.121.032 | ST | O 400 E LSN Optical smoke detector |
| 4.998.130.603 | ST | T 400 E LSN Thermal detector |
| 4.998.101.153 | ST | OC 310 GLT Multisensor detector optical / chemo |
| 4.998.025.351 | ST | OT 300 GLT Multisensor detector optical / thermal |
| 4.998.117.239 | ST | O 300 GLT Optical smoke detector |
| 4.998.025.354 | ST | T 300 GLT Thermal detector |

*LE = Delivery unit; ST = Pieces

8.2. Detectors for special application areas

| Product ID | LE* | Designation |
|---------------|-----|--|
| 4.998.117.239 | ST | O 300 (ware monitoring) Smoke detectors for fire barriers according to DIBt |
| 4.998.107.056 | ST | T 300/ FSA (ware monitoring) Thermal detectors for fire barriers according to DIBt |
| 4.998.131.147 | ST | OT 400 LSN KKW Multisensor detector optical / thermal for use in radioactive environments (nuclear power plant) |
| 4.998.131.148 | ST | O 400 LSN KKW Smoke detector for use in radioactive environment (nuclear power plant) as well as for fire barriers according to DIBt |
| 4.998.131.146 | ST | T 400 LSN KKW Thermal detector for use in radioactive environment (nuclear power plant) as well as for fire barriers according to DIBt |

8.3. Detector base

| Product ID | LE* | Designation |
|---------------|-----|--|
| 4.998.021.535 | ST | MS 400 Standard - detector base for surface-mounted and concealed cable insertion |
| 4.998.079.480 | ST | MSF 400 Detector base with damp room seal, for surface-mounted and concealed cable insertion |
| 4.998.113.025 | ST | MSC 420 Additional base surface-mounted with damp room seal for surface-mounted cable insertion especially using cable protection ducts. |

*LE = Delivery unit; ST = Pieces

8.4. Detector base sirens

| Product ID | LE* | Designation |
|---------------|-----|--|
| 4.998.025.371 | ST | MSS 300 Detector base siren, white, only C-point activation via put-on detector, for surface-mounted and concealed cable insertion |
| 4.998.120.501 | ST | MSS 300 WS - EC Detector base siren white, only for separate activation e.g. via NSB 100 LSN, for surface-mounted and concealed cable insertion |
| 4.998.107.443 | ST | MSS 300 - SA (no detector can be put on!) Detector base siren red, with cover plate, C-point activation for surface-mounted and concealed cable insertion |
| 4.998.098.974 | ST | MSS 400 LSN Detector base siren white, supply via LSN, C-point activation via put-on detector or external activation via the LSN, for surface-mounted and concealed cable insertion |
| 4.998.107.445 | ST | MSS 400 LSN - SA (no detector can be put on!) Detector base siren red, with cover plate, power supply via LSN, for surface-mounted and concealed cable insertion |
| 4.998.102.859 | ST | MSS 401 LSN Detector base siren white, separate supply, C-point activation via put-on detector or external activation via the LSN, for surface-mounted and concealed cable insertion |
| 4.998.107.446 | ST | MSS 401 LSN - SA (no detector can be put on!) Detector base siren red, with cover plate, Separate power supply, for surface-mounted and concealed cable insertion |
| 4.998.137.604 | ST | MSS 401 LSN - SA WS (no detector can be put on!) Detector base siren white, with cover plate, Separate power supply, for surface-mounted and concealed cable insertion |



8.5. Installation accessories

| Product ID | LE * | Designation |
|---------------|------|--|
| 4.998.097.924 | ST | MK 400 Console incl. base, for wall fastening according to DIBt |
| 2.799.271.257 | ST | Installation angle (without detector base), with mounting material for false floors |

8.6. Detector accessories

| Product ID | LE * | Designation |
|---------------|------|--|
| 4.998.084.709 | PAK | TP 4 400 Support Plate for Detector Zones Identification up to 4 m installation height (1 PACK = 50 pieces) |
| 4.998.084.710 | PAK | TP 8,400 Support Plate for Detector Zones Identification up to 8 m installation height (1 PACK = 50 pieces) |
| 4.998.025.369 | ST | SK 400 Basket guard against mechanical damage |
| 4.998.035.312 | PAK | SSK 400 Protective dust cover (1 PACK = 10 pieces) |
| 4.998.025.373 | ST | MH 400 Detector heating element |

*LE = Delivery unit; ST = Pieces; PAK = Pack

8.7. MPA External Detector Alarm Display

| Product ID | LE * | Designation |
|---------------|------|---|
| 2.799.330.669 | ST | External detector alarm display MPA external detector alarm display according to DIN 14 623 |

9. Installation of the Detector Module

☞ The packaging of the multisensor detector with C-sensor consists of tearproof PE-ALU laminated film and must be cut open carefully.

After installation and connection of the base, the detector module is set into the base and turned to the right until it stops.

The detector module can only be placed in the base in the correct position!

9.1. Locking the Detector Module in the Base

The detector module can be locked in the base (removal protection).

Detector modules are delivered with inactive locking!

The locking is activated by breaking the bars (X) out of the base and pushing them into the corresponding guides, as shown in the pictures

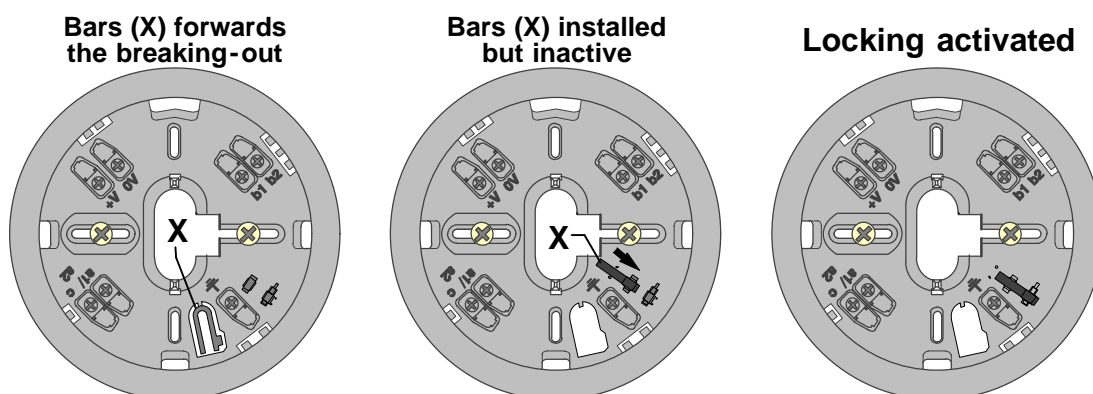

10. Dismounting the Detector Module

Unlocked detector modules are dismantled by turning them to the left and taking them out of the base.

Locked detector modules are dismantled by sticking a screwdriver into the unlocking opening (Y) so that the bar is pushed upward; at the same time, turn the detector module to the left.

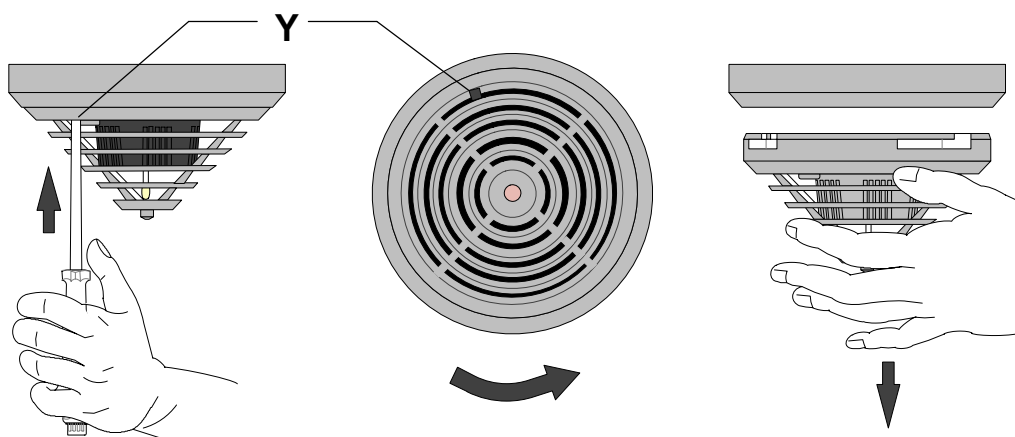

11. Maintenance and service

For maintenance and inspection work on danger detector systems, in Germany the regulations of DIN VDE 0833 apply, which refer to the maintenance interval according to the manufacturer's instructions.

- Maintenance and inspection work should be carried out regularly and by trained personnel.
- BOSCH ST recommends a functional and visual inspection at least once a year.

| Testing \ Detector type | O | T | OT | OC | OTC |
|--|---|---|----|----|-----|
| Check of the display LED | x | x | x | x | x |
| Visual check of the fastening | x | x | x | x | x |
| Visual check for damage | x | x | x | x | x |
| Checking that the monitoring area is not limited | x | x | x | x | x |
| Triggering with hot air | - | x | x | - | x |
| Triggering with Solo A3-001 testing gas | x | - | x | x | x |
| Triggering with CO testing gas | - | - | - | x | x |

- **Multisensor detectors with C-sensors must be exchanged every 5 years.**

☞ OTC 410 LSN / OC 410 LSN:

Depending on the lifespan of the gas sensor, the detector OTC 410 LSN and OC 410LSN switches the C-sensors off after 5 years of operation. On the central unit, the detector in question is displayed with "EMERGENCY OPERATION" and it continues to function as an OT or O detector.

The detector should be exchanged immediately in order to be able to keep using the higher detection security of the OTC and OC.

☞ OC 310 GLT:

Depending on the lifespan of the gas sensor, with the OC 310 GLT the C-sensor is switched off after approximately 5 years of operation; the detector continues to function as an O detector.

Depending on the system, there is no report to the central unit and the switching-off of the C unit is only noticed when the detectors are tested. Therefore the OC 310 should be exchanged in timely fashion before 5 years of operation have elapsed.

- **Optical fire detectors (smoke detectors) should, depending on the environmental conditions, be cleaned and exchanged every 4 - 6 years.**

☞ In especially dusty environments, cleaning and exchange may be necessary earlier!

11.1. Notes for the service: display of the operating data



With the exception of the special KKW detector types, for all configured detectors you can use the WinPara programming software (V 4.53 or higher) to display the serial number, degree of contamination, operating hours, and current analog values.

Display of the operating data

| BG-Adr. | Adresse | Kurzinfo | Typ | Seriennummer | Optik-Wert | Temp.-Wert(*C) | CO-Wert | Betr.-Std.-Zähler Jahre/Tage/Std. | Fehlercode C-Störung | Verschmutzung |
|---------|---------|-----------------|--------|--------------|------------|----------------|---------|--------------------------------------|-------------------------|---------------|
| 1 | 2-01 | O400 auf MSS400 | O400 | 2000480 | 94 | 24 | -- | 0/130/ 4 | 00000000 | 0 |
| 1 | 3-01 | OTC410 | OTC410 | 3910020 | 110 | 28 | 0 | 0/ 27/ 4 | 00000000 | 0 |
| 1 | 4-01 | OT400 | OT400 | 3931859 | 71 | 24 | -- | 0/ 27/12 | 00000000 | 0 |
| 1 | 7-01 | | O400 | 2000439 | 91 | -- | -- | 0/245/12 | 00000000 | 0 |
| 1 | 7-02 | | O400 | 2000489 | 82 | -- | -- | 0/293/16 | 00000000 | 0 |
| 1 | 7-03 | | O400 | 2000467 | 75 | -- | -- | 0/288/ 8 | 00000000 | 0 |
| 1 | 7-04 | | O400 | 2000481 | 89 | -- | -- | 0/285/16 | 00000000 | 0 |
| 1 | 7-05 | | O400 | 2000468 | 86 | -- | -- | 0/288/ 4 | 00000000 | 0 |
| 1 | 7-06 | | O400 | 2000479 | 88 | -- | -- | 0/287/12 | 00000000 | 0 |
| 1 | 9-01 | | OT400 | 3908955 | 83 | 23 | -- | 0/130/ 4 | 00000000 | 0 |
| 1 | 10-01 | O400 | O400 | 2000486 | 73 | -- | -- | 0/241/20 | 00000000 | 0 |
| 1 | 10-02 | O400 | O400 | 2000466 | 78 | -- | -- | 0/247/ 0 | 00000000 | 0 |
| 1 | 10-03 | O400 | O400 | 2000455 | 94 | -- | -- | 0/294/ 4 | 00000000 | 0 |
| 1 | 10-04 | O400 | O400 | 2000478 | 84 | -- | -- | 0/287/ 4 | 00000000 | 0 |
| 1 | 10-05 | O400 | O400 | 2000472 | 83 | -- | -- | 0/287/12 | 00000000 | 0 |
| 1 | 10-06 | O400 | O400 | 2000445 | 65 | -- | -- | 0/284/16 | 00000000 | 0 |
| 1 | 10-07 | O400 | O400 | 2000474 | 77 | -- | -- | 0/251/20 | 00000000 | 0 |

Übertragungstatus: fertig

BG-Adr.:

module (NVU/LVM) on which the detector or detector line is installed.

Address:

Installation address of the detector

e.g. 10-03: The detector is in the detector group 10 and has the detector number 3.

Brief info:

additional information entered during programming, e.g. "O400 to MSS400" means that the O 400 E LSN is installed together with a detector base siren MSS 400. Here you can also enter the position of the detector.

Type:

display of the set detector type.

Serial number:

the first number of the 8-digit serial number specifies the year of manufacture, that is, the detector with the serial number 3931859 was manufactured in 2003.

Current analog values:

- **Optical system value:** (display of the current contamination value)
 - 0 . . . 170 Initial set-up value for a new detector.
 - 0 . . . 350 Normal working range.
 - 350 . . . 450 Slight contamination ⇒ exchange detector soon.
 - 450 . . . 510 Heavy contamination ⇒ **exchange detector immediately!**
 - as of 511 O fault ⇒ **optical sensor is switched off!**
- **Optical system value for special O 400 LSN for RAS 100 LSN:**
 - 0 . . . 500 Initial set-up value for a new detector.
 - 0 . . . 700 Normal working range.
 - 700 . . . 800 Slight contamination ⇒ exchange detector soon.
 - 800 . . . 880 Heavy contamination ⇒ **exchange detector immediately!**
 - as of 881 O fault ⇒ **optical sensor is switched off!**
- **Temp. value [°C]:** (display of the current measurement value of the temp. probe)
 - 20 . . . +65°C OT 400 E LSN / T 400 E LSN.
 - 10 . . . +50°C OTC 410 E LSN.
- **CO value:** (display of the current measurement value of the CO sensor)
 The CO value specifies the currently-measured CO concentration. Here the specified number is calculated as the difference between the current measurement value and the stand-by value stored in the detector. The CO concentration displayed lies in the range between 0 (normal state) and 555 (max. measurement value of the sensor).

Operating hours counter: display of the duration of operation since the initial start-up of the detector.

Error code C malfunction: (cause, effect, and troubleshooting)

| Error code | Cause of trouble and troubleshooting |
|------------|---|
| 01000000 | General C malfunction! Possible causes: - malfunction of the temperature sensor - maximum operation duration (5 years) of the C-sensor has been exceeded. ⇒ T-/ and C sensors are switched off, the optical sensor is still operating. ☞ Exchange detector immediately! |
| 01100000 | The impedance of the electrochemical cell is too high! ⇒ The C sensor is switched off, the rest of the sensors are still operating. ☞ Exchange detector immediately! |
| 01010000 | The permissible operating temperature range (-10°C to +50°C) has been exceeded! ⇒ The C-sensor is switched off, the rest of the sensors are still operating. |
| 01001111 | Malfunction due to read/write error in the EEPROM! ☞ Detector is switched off and must be exchanged immediately! |
| 00000xxx | Number of read/write errors in the EEPROM! |

Contamination:

The optical initial set-up value of a new detector is stored in the integrated EEPROM during the final inspection. The contamination value specifies by how much this analog value has increased in comparison to the delivery state.



11.2. Test Instructions for MAGIC.SENS Fire Detectors

The newest generation of MAGIC.SENS OTC 410 LSN/ OC 410 LSN and OC 310 GLT multisensor fire detectors have an additional sensor for CO detection in case of fire. The CO sensor causes improved response behavior and increased malfunction suppression in critical environmental conditions.

For fire recognition, MAGIC.SENS detectors use the time behavior of the fire variables that deviates significantly from the time behavior of disturbance variables and also from the time behavior of a detector check with aerosol.

Therefore, for a functional test, the detector must be switched into maintenance mode. Switching into maintenance mode occurs differently for LSN and GLT detectors.

11.3. Inspection procedure for MAGIC.SENS OTC 410 LSN / OC 410 LSN

- Switch the detector zone to be inspected into maintenance mode on the central unit. Thus the detector is set automatically into maintenance operation and prepared for the detector test.

☞ Only in maintenance operation can the detector's individual sensors be made to trigger one after the other with the corresponding test device. For this, you should use the service accessories we recommend.

- The optical sensor is tested with the detector tester for smoke detectors with the Solo A3-001 testing gas.

NOTE: The transceiver must remain over the detector until the detector has been triggered. The distribution of the test aerosol in the transceiver and thus the triggering time of the sensor can take up to 10 seconds.

- To test the CO - sensor, the same test device is used, but exchange the testing gas bottle Solo A3-001 for the CO testing gas bottle. For the CO - test, a testing gas application of 1/2 to 1 seconds in duration must be made.

NOTE: The transceiver must remain over the detector until the detector has been triggered. The distribution of the CO gas in the transceiver and thus the triggering time of the sensor can take up to 20 seconds.

- The temperature sensor of the OTC is tested with the test device for heat detectors.

11.4. Test procedure for MAGIC.SENS OT 400 E LSN / O 400 E LSN

- Switch the detector zone to be inspected into maintenance mode on the central unit. Thus the detector is set automatically into maintenance operation and prepared for the detector test.

☞ Only in maintenance operation can the detector's individual sensors be made to trigger one after the other with the corresponding test device. For this, you should use the service accessories we recommend.

- The optical sensor is tested with the detector tester for smoke detectors with the Solo A3-001 testing gas.

NOTE: The transceiver must remain over the detector until the detector has been triggered. The distribution of the test aerosol in the transceiver and thus the triggering time of the sensor can take up to 10 seconds.

- The temperature sensor of the OT is tested with the test device for heat detectors.



11.5. Test procedure for MAGIC.SENS OC 310 GLT

With the OC 310 you must first test the optical unit with the test aerosol. After triggering the O unit, the detector must be reset. Thus the CO sensor is switched into maintenance mode for 15 minutes and it can then be tested. Since the aerosol test for the detectors works like a disturbance signal, (very large signal with very quick increase), the signal evaluation for disturbance variable is brought to bear and the alarm occurs only after approximately one minute.

- Position detector testers for smoke detectors on the OC 310 GLT.
- Spray aerosol (1 to 2 seconds).
 - ☞ Do not remove test device from the detector; the O unit triggers only approximately 60 seconds after the application of the test aerosol.
- Reset detector.
 - ☞ Thus the detector is switched into maintenance mode.
- Place CO gas bottle in the test device.
- Position test device on the detector.
- Apply CO gas for $\frac{1}{2}$ to 1 second.
 - ☞ The C sensor triggers after approximately 20 seconds.

11.6. Inspection procedure for OT 300 GLT / O 300 GLT

- Position detector testers for smoke detectors on the OT 300 GLT / O 300 GLT.
- Spray aerosol (1 to 2 seconds).
 - ☞ Do not remove test device from the detector; the O unit triggers only approximately 30 seconds after the application of the test aerosol.
- Reset detector.
 - ☞ Thus the detector is switched into maintenance mode.
- The temperature sensor of the OT is tested with the test device for heat detectors.

11.7. Coding of the Detector Types

With the exception of the O types, all detectors are equipped for identification of the detector type with a colored ring around the central individual display.

This simplifies significantly the inspection by service personnel.

- **yellow** ⇒ **OTC**
- **black** ⇒ **OT**
- **blue** ⇒ **OC**
- **red** ⇒ **T**
- **-** ⇒ **O**

- **green** ⇒ **O 400LSN for RAS 100 LSN** (special detector that may only be used in the smoke extraction system RAS 100 LSN)

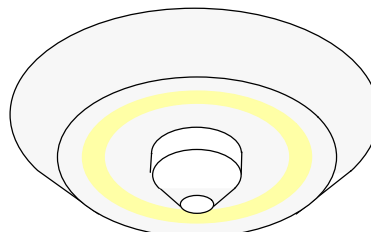

12. Repair

In case of defect, the detector is exchanged completely.

13. Disposal

Packaging Film of the Fire Detectors with C-Sensor

The packaging bag of the multisensor detector with C-sensor consists of tearproof PE-ALU laminated film and may be thrown away with the garbage.

Defective detectors are exchanged and should be disposed of in accordance with legal regulations.

14. Additional Documentation



For those with access authorization, on the Bosch ST ExtraNet at www.boschsecurity.com/emea/fire

the current information for each product, as well as the installation instructions supplied with the device, are available for download as a PDF file.



14.1. Service Accessories



| Product ID | LE* | Designation |
|---------------|-----|--|
| 4.998.112.113 | ST | Universal detector exchanger. |
| 4.998.112.071 | ST | Test device for optical smoke detectors. |
| 4.998.112.074 | ST | Solo A3-001 smoke detector testing gas, 250 ml spray can; (1 PACK = 12 pieces) |
| 4.998.142.221 | PAK | Solo CO testing aerosol for detectors with CO sensors; contents: approx. 4 litres compressed gas; (1 PACK = 12 pieces) |
| 4.998.112.072 | ST | Test set (wireless) for heat detectors, consisting of detector tester, 2 rechargeable battery bars, and charging set with network and vehicle plugs. |
| 4.998.112.069 | ST | Telescope rod (1 m – 3.38 m) of fiberglass. can be extended with max. 3 extension rods. |
| 4.998.112.070 | ST | Extension bar of fiberglass (1 m). |
| 4.998.112.073 | ST | Transport bag for the test devices and their accessories. |

*LE = Delivery unit; ST = Pieces; PAK = Pack

14.2. Spare parts for the service accessories

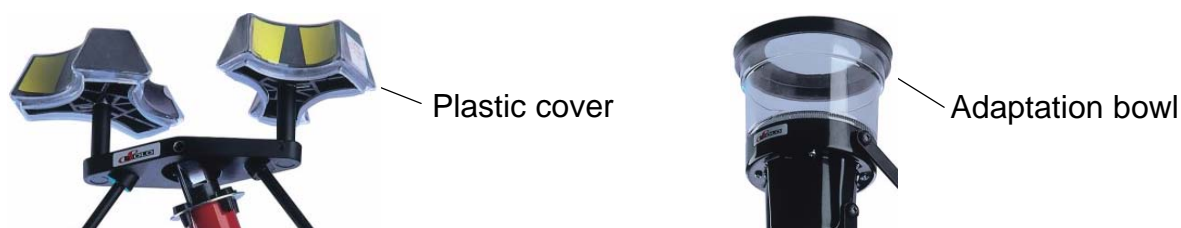

| Product ID | LE* | Designation |
|---------------|-----|--|
| 4.998.082.502 | ST | Plastic cover for the detector exchange attachment (2 pieces are required for the universal detector exchanger). |
| 4.998.072.024 | ST | Adaptation bowl for the smoke detector test device from the service set with the item number 2.799.330.868 |



15. Abbreviations

| | | |
|------|---|--|
| ABS | = | A crylnitrile B utadiene S tylene |
| aP | = | auf P utz (surface-mounted) |
| BMZ | = | C entral f ire a larm system |
| DIBt | = | D eutsches I nstitut für B autechnik (German Institute for Technology) |
| DIN | = | G erman I nstitute for S tandardization |
| EN | = | E uropean S tandard |
| GLT | = | D Ccurrent l ine t echnology |
| LED | = | L ight E mitting D iode |
| LSN | = | L ocal S ecurity N etwork |
| PI | = | P roduct i nformation |
| PP | = | P olypropylene |
| UEZ | = | U niverselle E uropazentrale (Universal European Central) |
| UGM | = | U niverselle G efahren m eldezentrale (Universal danger detector control unit) |
| uP | = | unter P utz (concealed) |
| VDE | = | A ssociation of G erman E lectrical Engineers |
| VdS | = | VdS Schadenverhütung GmbH |
| OTC | = | O ptical, t hermal, c hemical (gas) |
| OT | = | O ptical, t hermal |
| OC | = | O ptical, c hemical (gas) |
| O | = | O ptical |
| T | = | T hermal |



Bosch Security Systems
Robert-Koch-Str. 100
D-85521 Ottobrunn

Info-Service

Telephone: +49 89 6290 - 1039

Fax: +49 89 6290 - 1039

www.boschsecurity.com

info.service@de.bosch.com